



# F767 Document Feeder F774 & F772 High Capacity Loaders



**Operator Guide**  
English Version



# Table of Contents

## Chapter 1—Introduction

Important Safety Notes .....	1-2
A Note to the Operator .....	1-4
About Your System .....	1-4
The F767 Document Feeder .....	1-4
The F774/F772 High Capacity Loader .....	1-5
System Components - F767 .....	1-6
Operator Controls - F767 .....	1-10

## Chapter 2—Operation

F767 Document Feeder Setup .....	2-2
Accumulator Input Frame Position .....	2-2
Accumulator Ramp Height .....	2-2
Power Up .....	2-3
Select the Program .....	2-4
Loading Orientation .....	2-5
Feeder Side Guides Adjustment .....	2-6
Set the Scanning Head .....	2-7
Side to Side Adjustment of OMR Scanners .....	2-8
Side to Side Adjustment of BCR Scanners .....	2-10
Setting the Material Guide Fingers .....	2-12
Feeder Head Adjustment for cut sheets and booklets up to 2.5mm thick .....	2-13
Feeder Head Adjustment for booklets 2.5mm thick or greater .....	2-14
Transport Material to Accumulator .....	2-15
Setting the Accumulator Side Guides .....	2-15
Accumulator Ramp Adjustment .....	2-15
Deactivate Inline Test? .....	2-16
Load Paper .....	2-16
Running the System .....	2-17

# Table of Contents

---

## Chapter 3—Programming

About Programming Jobs .....	3-2
Adding a Non-Scanning Program .....	3-2
Adding a Scanning Program.....	3-5
Programming an 'OMR DI900/DI950' Job .....	3-5
Programming a 'BCR Standard' Job .....	3-11
Deleting a Program.....	3-13
Modifying a Program.....	3-14

## Chapter 4—Troubleshooting and Maintenance

The User's Menu .....	4-2
Options Available .....	4-2
Handling Material Stoppages.....	4-3
Stoppages in the F767 Document Feeder .....	4-3
Troubleshooting Charts .....	4-5
Troubleshooting Using the F767 Scan Error Screens .....	4-8
Operator Maintenance .....	4-8

## Chapter 5—Reference

Service.....	5-2
Compliance .....	5-2
Equipment Specifications .....	5-3
Material Specifications.....	5-4

## Index

Index.....	Index-1
------------	---------

# Contact Information

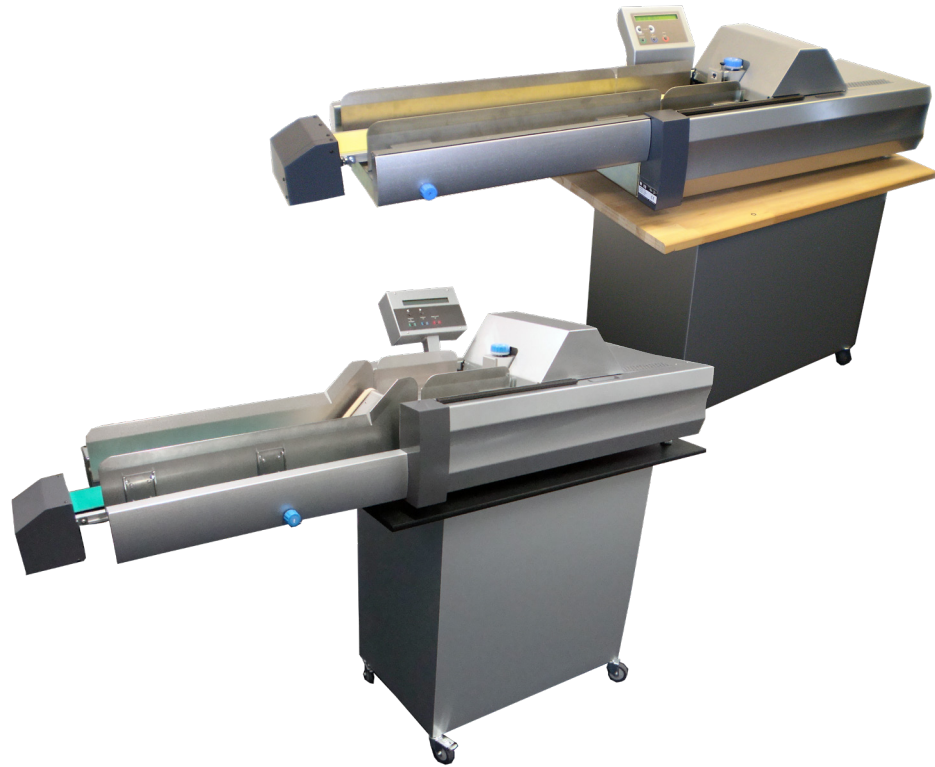

- If you require help or wish to purchase supplies for your system, contact your machine supplier.
- Contact information for all European Pitney Bowes companies is given in a separate publication supplied with your system.
- If your system has been provided by a dealer or company outside the European area, contact details will be on the rear cover of this guide, or on a label fixed to the machine.



# 1 • Introduction

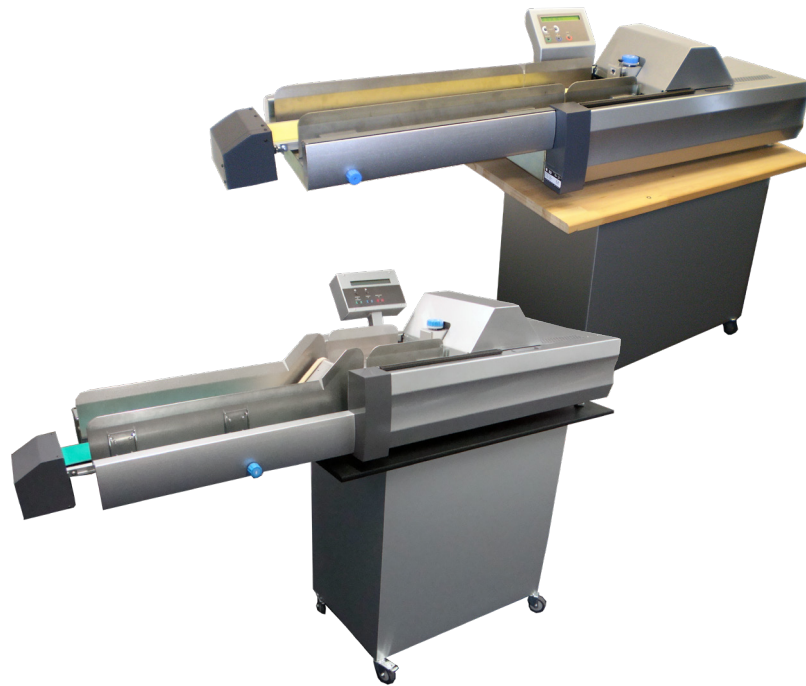

This chapter lists the key features of your system, and presents important safety information.

Important Safety Notes.....	1-2
A Note to the Operator.....	1-4
About Your System.....	1-4
The F767 Document Feeder .....	1-4
The F774/F772 High Capacity Loaders.....	1-5
System Components - F767.....	1-6
Operator Controls - F767.....	1-10

# 1 • Introduction

---

## Important Safety Notes

Follow the normal safety precautions for all office equipment:

- It is strongly recommended that you use only Pitney Bowes approved supplies, in particular aerosol dusters. Improper storage and use of aerosol dusters or flammable aerosol dusters, can cause an explosive-like condition that could result in a personal injury and/or property damage. Never use aerosol dusters labelled flammable and always read instructions and safety precautions on the duster container label.
- To obtain supplies, please contact our Supply Line™ to place orders. Material Safety Data Sheets can be obtained on the web or from our Supply Line™. Refer to the Contact Information List for more information.
- Use the power cord supplied with the machine and plug it into a properly grounded wall outlet located near the machine and easily accessible. Failure to properly ground the machine can result in severe personal injury and/or fire.
- Avoid touching moving parts or materials while the machine is in use. Keep hands, loose clothing, jewellery and long hair away from all moving parts.
- Do not remove covers or defeat safety interlock switches. Covers enclose hazardous parts that should only be accessed by properly trained service personnel. Immediately report to service any damaged or non-functioning components that renders the unit unsafe.
- Place the unit in an accessible location to allow for proper venting of the equipment and to facilitate servicing.
- The power cord wall plug is the primary means of disconnecting the machine from the AC supply.
- Do not use an adapter plug on the line cord or wall outlet.
- Do not remove the ground pin from the line cord.
- Avoid using wall outlets that are controlled by wall switches, or shared with other equipment.
- Do not route the power cord over sharp edges or trap between furniture.



**Important  
Safety Notes  
(continued)**

- Ensure there is no strain on the power cord and that it does not become jammed between the equipment, walls or furniture.
- Be certain the area in front of the wall receptacle into which the machine is plugged is free from obstruction.
- Before clearing a stoppage, be sure machine mechanisms come to a stop.
- When removing stalled material, avoid using too much force to protect against minor personal injury and damaging equipment.
- To prevent overheating, do not cover any vent openings.
- Operation of this equipment without periodic maintenance will inhibit optimum operating performance and could cause the equipment to malfunction. Contact your machine supplier for required service schedule.
- Read all instructions before attempting to operate the equipment.
- Use this equipment only for its intended purpose.
- Always follow the specific occupational safety and health standards for your workplace.

# 1 • Introduction

---

## **A note to the Operator**

These instructions explain how to setup and use the Model F767 Document Feeder and the optional Model F774/F772 High Capacity Loader. Please spend a few moments reading through them; understanding what the system does and how it does it will keep problems to a minimum and help you get the best performance from it and the DI900/DI950 inserting system of which it is a part.

Before setting up and using the system, you should be thoroughly familiar with its controls, programming options and setup procedure. You should also be thoroughly familiar with each component of the DI900/DI950 system (see the DI900/DI950 Operator Guide supplied with the system).

## **About Your System**

### ***The F767 Document Feeder***

The F767 is used as part of the Pitney Bowes DI900/DI950 Inserting System. It takes laser printed, or pre-printed cut sheet forms and efficiently collates them into customer sets. It can also feed single booklets up to 4mm thick. OMR/BCR/OCR/2D Matrix scanning ensures complete integrity and confidentiality of the sets.

### **Standard Features**

The F767 offers an impressive array of standard features. Among them:

- Bottom feeding of material
- Variable speed control
- Overcount control
- Automatic double document detection
- Job storage - up to 99 jobs available
- Multi-function operator controls
- Easy to use self prompting display
- Out of material and jam detection
- Resettable sheet counter
- Batch count control
- Operator selectable scan line increments: 1/6", 1/8", 1/10" and 'User Definable' (if OMR scanning is fitted)

### **The F774/F772 High Capacity Loaders**

The optional F774/F772 High Capacity Loaders take laser printed or pre-printed cut sheets and inserts and conveys them to the feeder deck of the F767 Document Feeder.

After loading material into the F774/F772, operation is controlled by the F767 Document Feeder, as a result of which the F774/F772 will only convey material when instructed to do so by the Universal Feeder.

In the event of a material stoppage in the Document Feeder, the F774/F772 High Capacity Loader will stop.

#### **Standard Features:**

- High Capacity, up to a maximum of 4,500 pieces
- Automatic start/stop – Controlled by downstream F767 Document Feeder
- Automatic paper flow control
- Automatic material detection
- Fully interlocked covers'

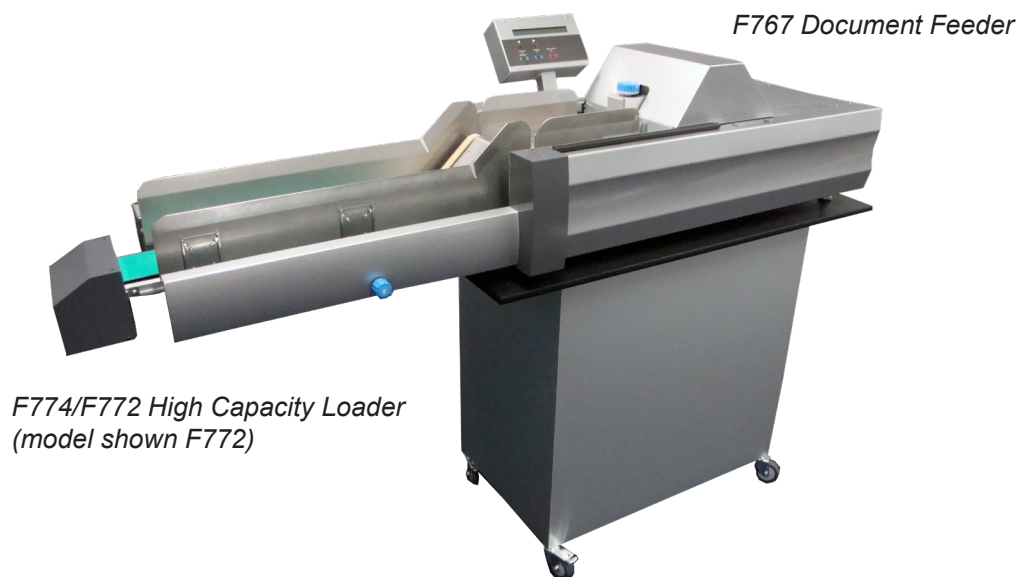

# 1 • Introduction

---

## System Components - F767

- 1 Control Panel**

Operator controls are conveniently grouped on the front of the feeder. Five multi-function controls govern all programming and paper handling functions. See page 1-12 for details.
- 2 Operator Display**

The display prompts you through the programming process, shows a list of available programs and displays error messages.
- 3 Feed Deck**

Equipped with side guides and separator assembly.
- 4 Top Cover**

Provides access to the accumulation area for making adjustments or clearing stalled material. The cover is interlocked to prevent machine operation when open.
- 5 Accumulation Area**

Area of the feeder where sheets are collated into sets prior to being fed into the DI900/DI950 system.
- 6 Feeder Head Adjustment Controls (a and c)**

Adjusts the separator and feed mechanisms so that single items of material are fed into the accumulation area.

Control **c** adjusts the initial separation of the material being run.

Control **a** adjusts the feed (take-away) of the single piece of material to the accumulation area. When the red lever (**a**) is down, the feed is locked. When the red lever (**a**) is up, the feed is unlocked.



# 1 • Introduction

---

## System Components - F767 (continued)

- 7 Main Power Switch**  
Applies power to the F767 Document Feeder and the F774/F772 High Capacity Loaders.
  
- 8 Feeder Side Guides and Controls**  
Used to control the material being fed into the system. Rotate the control to adjust the guides.
  
- 9 Material; Height Sensor**  
Used to control the amount of material feeding from the Loader to the Feeder Deck.  
Unscrew the black knob to move the sensor.  
To decrease the amount of material on the feed deck, lower the sensor.  
To increase the amount of material on the feed deck, raise the sensor.

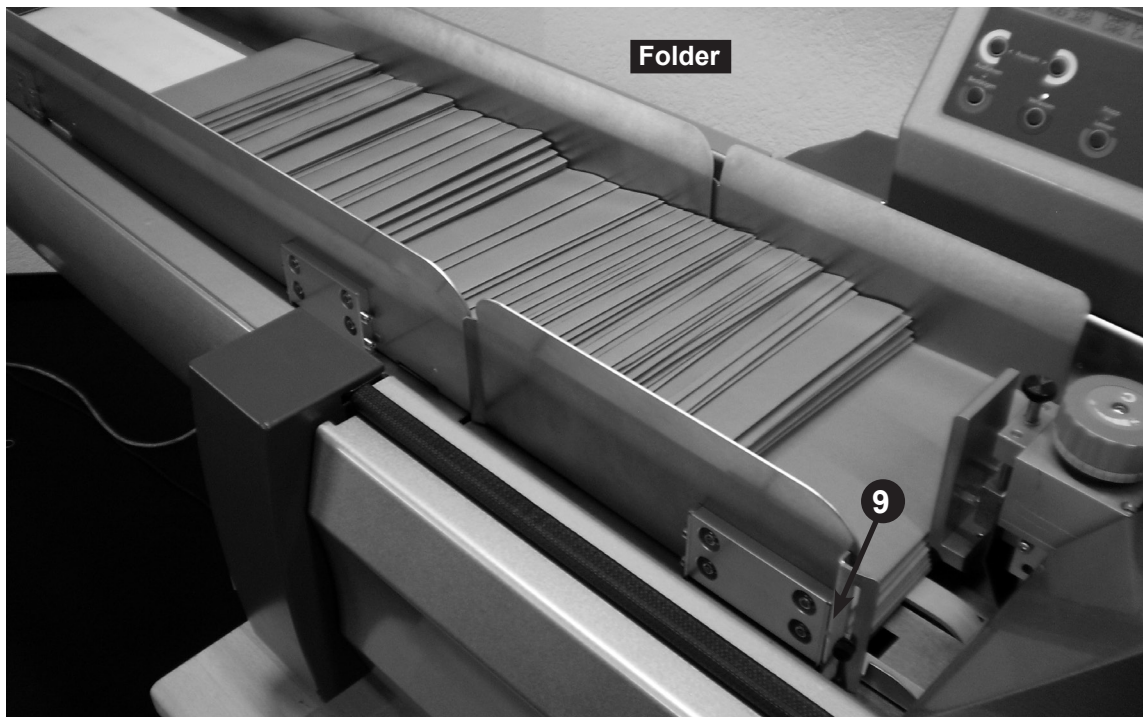
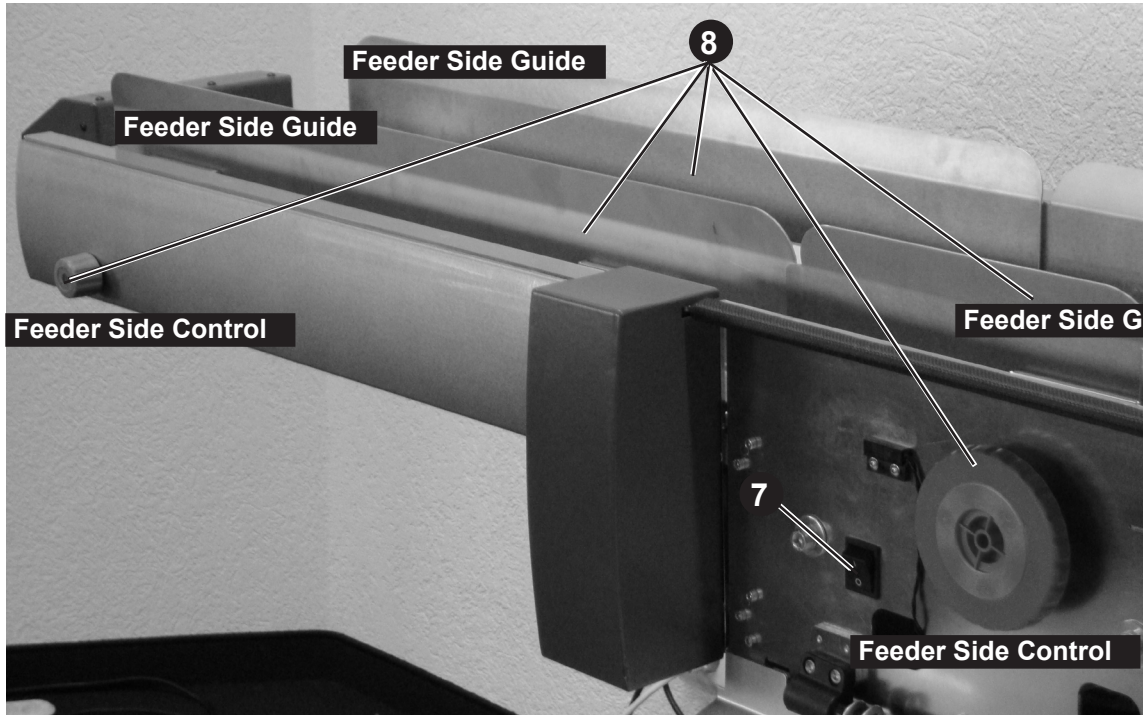

# 1 • Introduction

---

## Operator Controls - F767

### Arrow Buttons <>

1. In the operating mode, scroll through available (up to 99) programs in the program list.
2. In programming mode, select alpha or numeric characters or other variable settings.

### Run Confirm (Green)

In the programming mode, answers YES to prompts.

**After set-up with the pre-run adjustments, operation of the SYSTEM will be through the DI900/DI950 Inserter control panel. This includes both single cycle (Trial Piece) and continuous operation.**

### Exit (Blue)

Used when advancing through options in the programming mode.

### Stop/Clear Deck (Red)

In the programming mode, answers NO to prompts; also acts as a STOP button during continuous operation.

If material is in the accumulation area of the F767 i.e. the last set in a job run, pressing this button will eject the material through the DI900/DI950 Inserting System.



**F767 Universal Feeder Control Panel**



# 2 • Operation



This chapter tells you how to setup, load and run the F774/F772 High Capacity Loaders and the F767 Document Feeder.

F767 Document Feeder Setup .....	2-2
Accumulator Input Frame Position .....	2-2
Accumulator Ramp Height.....	2-2
Power Up.....	2-3
Select the Program.....	2-4
Loading Orientation .....	2-5
Feeder Side Guides Adjustment.....	2-6
Set the Scanning Head.....	2-7
Side to Side Adjustment of OMR Scanners.....	2-8
Side to Side Adjustment of BCR Scanners.....	2-10
Setting the Material Guide Fingers .....	2-12
Feeder Head Adjustment for cut sheets and booklets up to 2.5mm thick .....	2-13
Feeder Head Adjustment for booklets 2.5mm thick or greater .....	2-14
Transport Material to Accumulator.....	2-15
Setting the Accumulator Side Guides .....	2-15
Accumulator Ramp Adjustment .....	2-15
Deactivate Inline Test? .....	2-16
Load Paper .....	2-16
Running the System .....	2-17

## 2 • Operation

---

### F767 Document Feeder Setup

This section explains how to select a program and set the F767 for the material being run:

**NOTE:**

A support arm holds the Top Cover open.

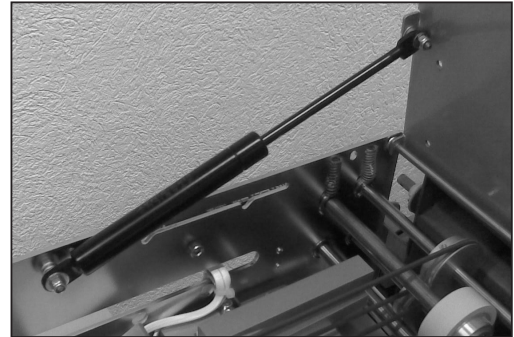

### Accumulator Input Frame Position

Lower the F767 Front Cover.

Set lever **d** to the required position:

- 3** for sheets
- 2** for thin booklets up to 2.5mm thick
- 1** for thick booklets up to 4mm thick

Close the Front Cover.

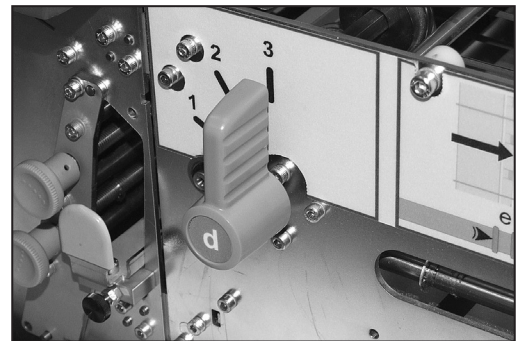

### Accumulator Ramp Height

Open the Top Cover.

The ramp must be set to the raised position for sheets or the lowered position for booklets. Simply grasp the ramp and set it to the required position.



**Raised for sheets**



**Lowered for booklets**

**NOTE:**

If the reverse accumulator kit is fitted to your machine, the ramp height has three settings controlled by the position of the lever **f** located inside the Front Cover:

- 1 for reverse accumulate of sheets  
i.e. sheet order ...3, 2, 1,
- 2 for booklets
- 3 for forward accumulate of sheets  
i.e. sheet order 1, 2, 3....

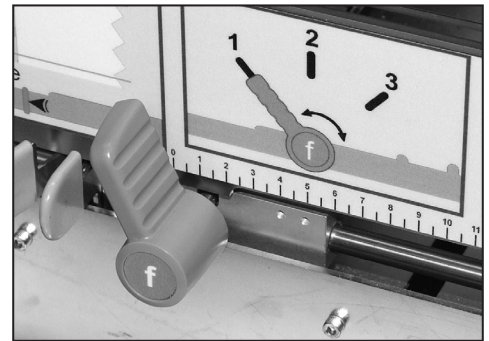

**Power Up**

Before turning the system ON, refer to the Important Safety Notes on page 1-2.

Turn the F767 Main Power Switch ON. The F767 will momentarily display the version number of the software, and then show the listing of available programs. The **Exit (Blue)** indicator will light.

**Program Listing**

012: JOB1	PAPER/DF C=1	<PROG
013: JOB2	PAPER/DF C=1	USB

USB indicates that the USB link to the DI900/DI950 Inserter is operational.

**HINT:**

If nothing happens, turn the Main Power Switch OFF. Make sure all covers are closed, then turn the Main Power Switch ON again.

## 2 • Operation

---

### Select the Program

The instructions which follow assume that the program you want is available from the list in the machine's memory. If necessary, see 'Adding a Non-Scanning Program' on page 3-2, or 'Adding a Scanning Program' on page 3-5 for programming instructions.

The display will show the last program run on the top line. Use the **Arrow Buttons** to scroll through the list of available programs.

To select a program, scroll so it appears on the first line of the display as indicated by the arrow and **<PROG** prompt. Press the **Green** button to select the program.

New program. Pre run adjustments?		
Green=YES	Blue=EXIT	Red=NO

The display asks if you wish to run pre-run adjustments. If this is a new job, press **Green** and carry out the adjustments as described on pages 2-5 to 2-13. If it is the current job, or the pre-run adjustments have already been completed, then press **Red**.

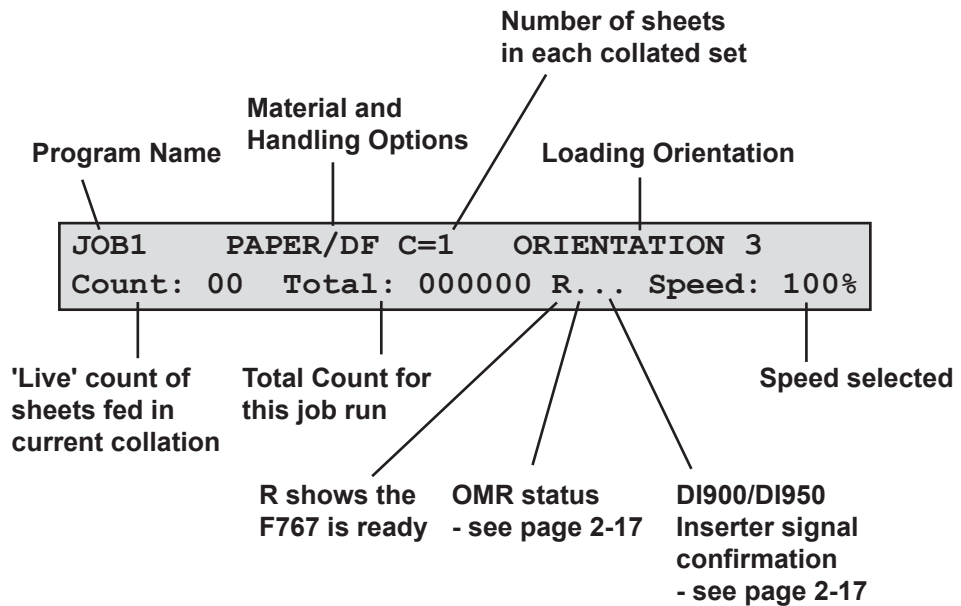

The display shows the program selected and the main program options.

To set speed, use the **Arrow Buttons** until the speed you want is displayed. You may need to adjust the speed when running booklets or certain paper finishes.

**Loading Orientation**

The Loading Orientation is shown when you select a program. There are four possible loading orientations:

- 1 Face up, bottom first
- 2 Face up, top first
- 3 Face down, bottom first
- 4 Face down, top first

When feeding individual pieces of material during setup, or when loading material prior to a job run, it is important to observe the correct loading orientation for the program selected.

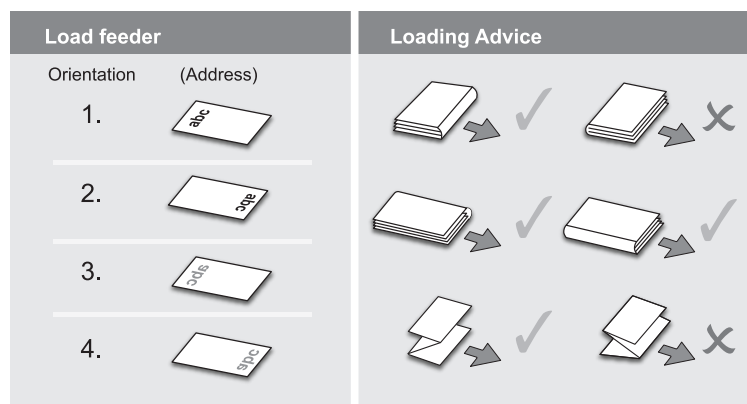

## 2 • Operation

---

### **Feeder Side Guides Adjustment**

Rotate the Feeder Side Guide adjusting wheel anticlockwise until the side guides are wider apart than the material to be run.

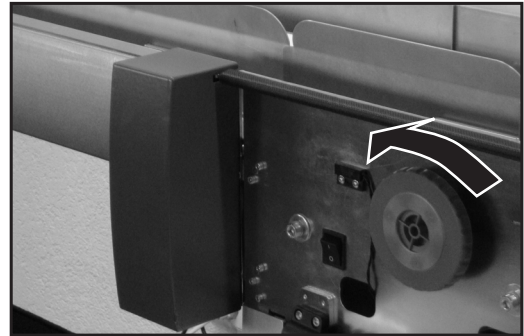

Place a sheet or booklet onto the Feed Deck.

Turn the Feeder Side Guide adjusting wheel clockwise to close the side guides up to the sheet or booklet, then turn it anticlockwise 6 notches allowing an overall clearance of approximately 3mm between the material and guides.

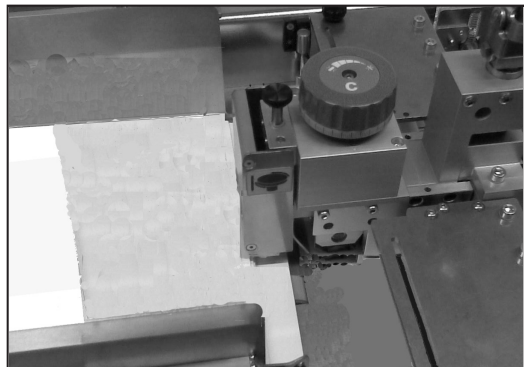

Loosen knob (1) first.

Move backstop (2) to left-hand side.

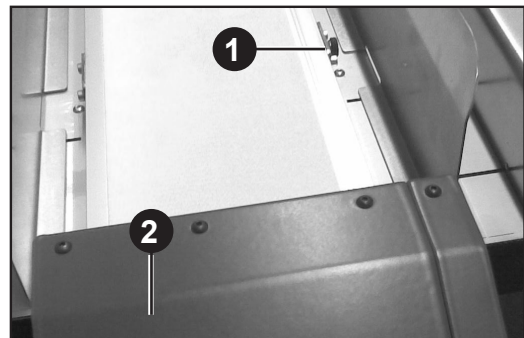

**F774-** Position the material as shown on the right and move backstop position to within 3mm of material.

Lock the backstop knob.

**Note-** For F772, see next page

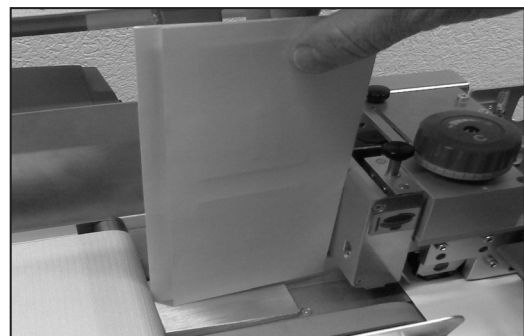

Place material (**2-10 pieces**) into the feed deck area (A) before loading material onto the belts.

Then load the bulk of the material shingled as shown on the right.

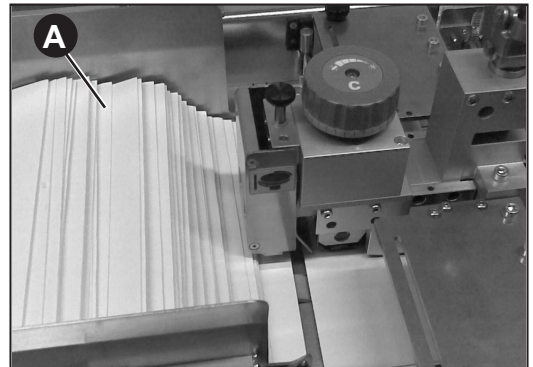

**F772-** Position the material as shown on the right and move backstop position to within 3mm of material.

Lock the backstop knob.

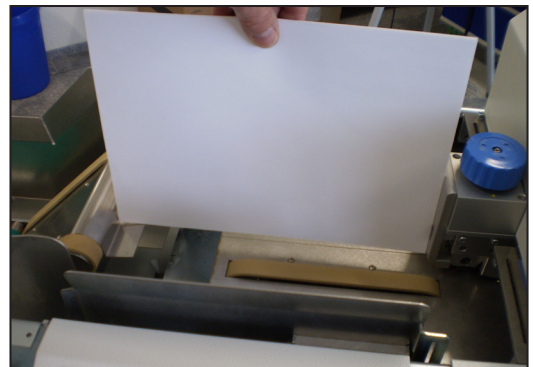

Place material (**100-200 sheets**) into the feed deck area (A) before loading material onto the belts.

Then load the bulk of the material shingled as shown on the right.

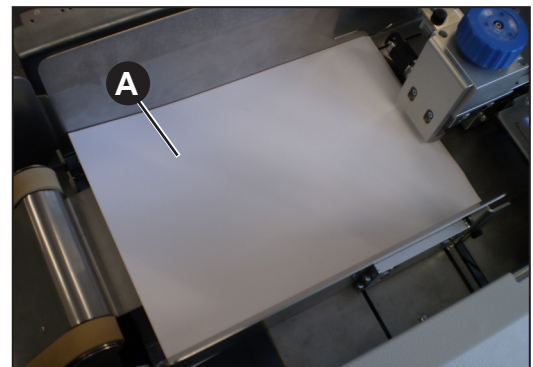

### **Set the Scanning Head**

The Scanning Head is used to read OMR/BCR/OCR/2D Matrix scan marks printed on your material. If you are using this option, carry out the following settings. If you don't use this option, continue with 'Setting the Material Guide Fingers' on page 2-10.

## 2 • Operation

---

### **Side to Side Adjustment of OMR Scanners**

#### **Bottom Scanning**

Connect power and turn ON. Open the Top and Front Covers.

Open the separator. Unlock lever **a**, turn knob **c** clockwise as far as it will go and hold in position while locking lever **a**.



The OMR scan marks are read from the underside of the sheet and so to be able to set the scanner position, you must mark their position on the upper face of the sheet.

Slide a sheet under the separator and observe the scanner beam on the sheet.

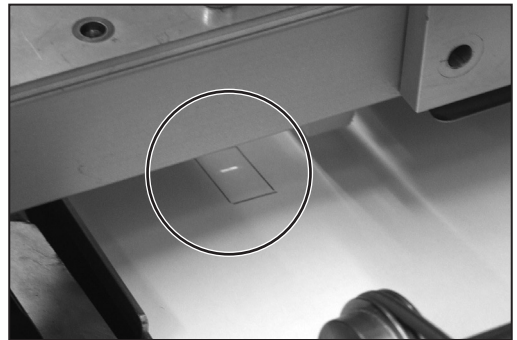

Adjust the scanner side to side until the beam is centred on the scan marks by manually sliding the scanner.

Close the covers.





### Top Scanning

Connect power and turn ON. Open the Top Cover.

Open the separator. Unlock lever **a**, turn knob **c** clockwise as far as it will go and hold in position while locking lever **a**.

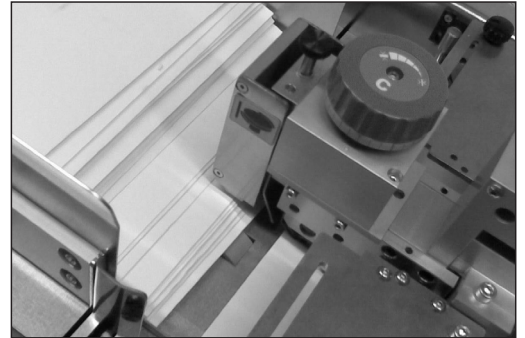

Slide a sheet under the separator and observe the scanner beam on the sheet.

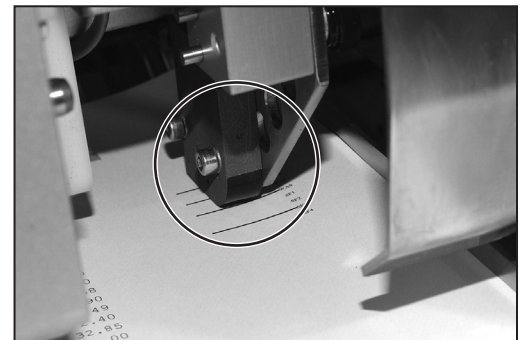

Adjust the scanner side to side until the beam is centred on the scan marks. Loosen the knurled knob shown, align the scanner and retighten the knob.

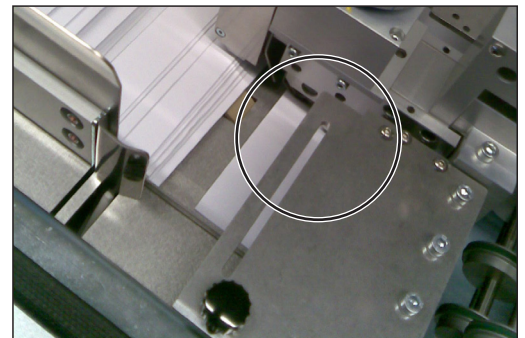

Close the cover.

## 2 • Operation

---

### **Side to side Adjustment of BCR Scanners**

#### **Bottom Scanning**

Connect power and turn ON. Open the Top and Front Covers.

Open the separator. Unlock lever **a**, turn knob **c** clockwise as far as it will go and hold in position while locking lever **a**.

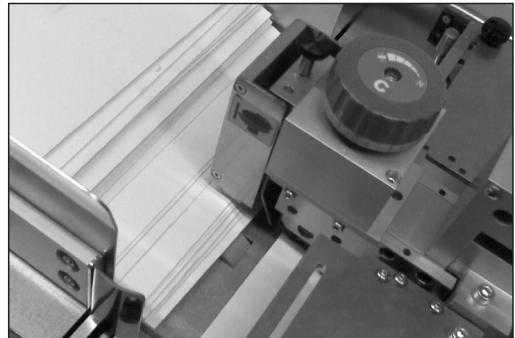

The BCR marks are read from the underside of the sheet and so to be able to set the scanner position, you must mark their position on the upper face of the sheet.

Press the **Green**, **Blue** and **Red** buttons at the same time to enter the Menu. Use the **Arrow Buttons** to select 'User Menu', then press **Green** to confirm. Use the **Arrow Buttons** to select 'BCR Test', then press **Green** to confirm.

If your system has more than one BCR scanner, use the **Arrow Buttons** to select 'BCR Location', then press **Green** to confirm. Select the location of the scanner you wish to test, then press **Green** to confirm.

Slide a sheet under the separator and observe the scanner beam on the sheet.

Adjust the scanner side to side until the marks are centred on the beam area, by manually sliding the scanner.

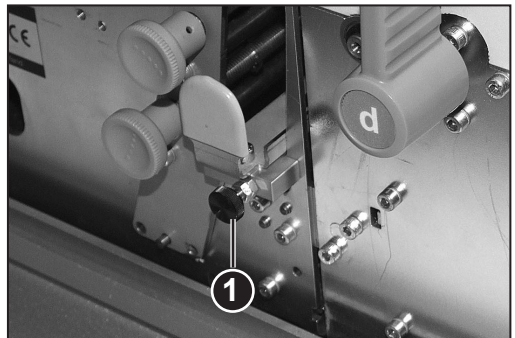

When in 'BCR Test', the scanner red lights will flash slowly. If the code is read successfully i.e. the scanner is correctly aligned, the lights will flash faster and the characters read will display on the operator display.

When the scanner is positioned correctly, tighten locking knob **1**.

Exit from the User Menu and close the covers.

### Top Scanning

Connect power and turn ON. Open the Top Cover.

Open the separator. Unlock lever **a**, turn knob **c** clockwise as far as it will go and hold in position while locking lever **a**.



Press the **Green**, **Blue** and **Red** buttons at the same time to enter the Menu. Use the **Arrow Buttons** to select 'User Menu', then press **Green** to confirm. Use the **Arrow Buttons** to select 'BCR Test', then press **Green** to confirm.

If your system has more than one BCR scanner, use the **Arrow Buttons** to select 'BCR Location', then press **Green** to confirm. Select the location of the scanner you wish to test, then press **Green** to confirm.

Slide a sheet under the separator and observe the scanner beam on the sheet.

Adjust the scanner side to side until the marks are centred on the beam area.

When in 'BCR Test', the scanner red lights will flash slowly. If the code is read successfully i.e. the scanner is correctly aligned, the lights will flash faster and the characters read will display on the operator display.



When the scanner is positioned correctly, exit from the User Menu.

Close the cover.

## 2 • Operation

---

### **Setting the Material Guide Fingers**

Open the Top Cover.

The guide fingers can be raised or lowered into one of three detented positions, depending on the material being run:

Lowered for sheets.

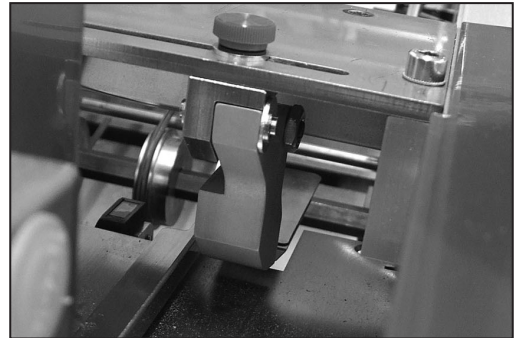

Mid position for thin booklets of approx. 2.5mm thickness.

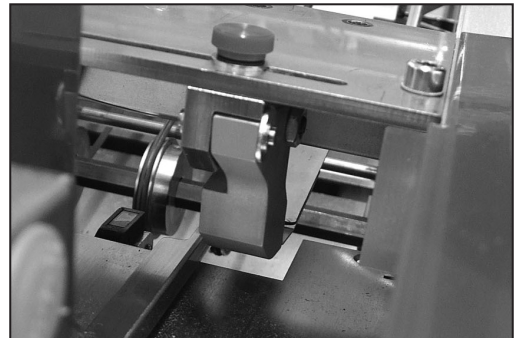

Raised for thick booklets up to 4mm thickness.

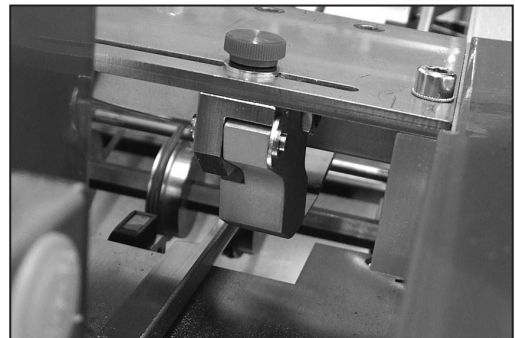

Loosen the knurled locking knobs and adjust the guide fingers side to side to control material. If bottom scanning is being used, one of the guide fingers must be positioned directly above the scanning head to control the material as it is scanned.

Close the cover.

**Feeder Head  
Adjustment for  
cut sheets and  
booklets up to  
2.5mm thick**

Open the Top Cover.

Turn knob **c** anticlockwise until it stops.

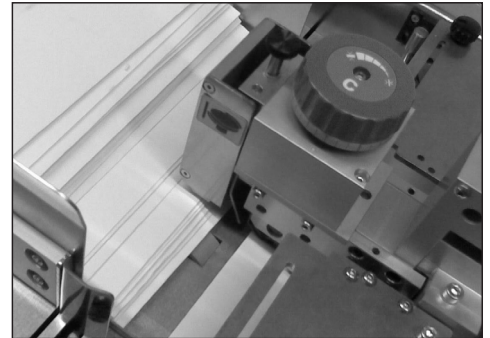

Raise lever **a** to unlock Feeder Head.

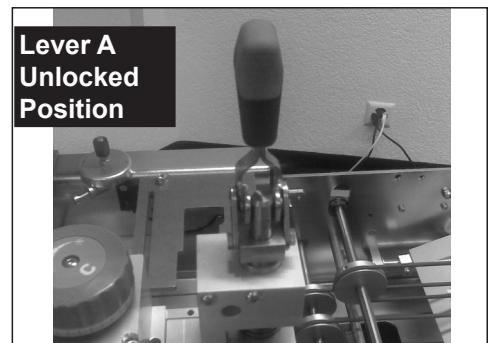

Place material under Feeder Head and lower lever **a** to lock into position.

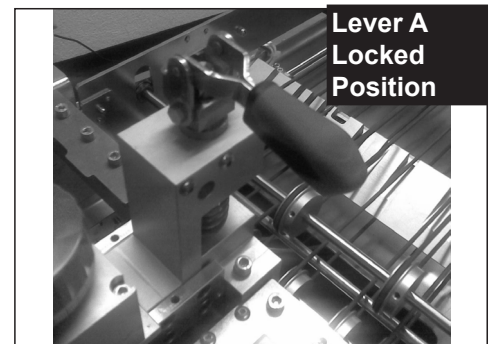

Close all covers and press the **Run Confirm (Green)** button to make the feeder motor run.

Take two pieces of the material to be run and feed them, by hand, into the separator. If both pieces feed completely under the separator, pull them out and tighten knob **c** clockwise slightly.

Repeat the previous step until only one piece feeds completely and the second piece is held back.

Adjust knob **b** to allow a single piece to feed to knob **c**.

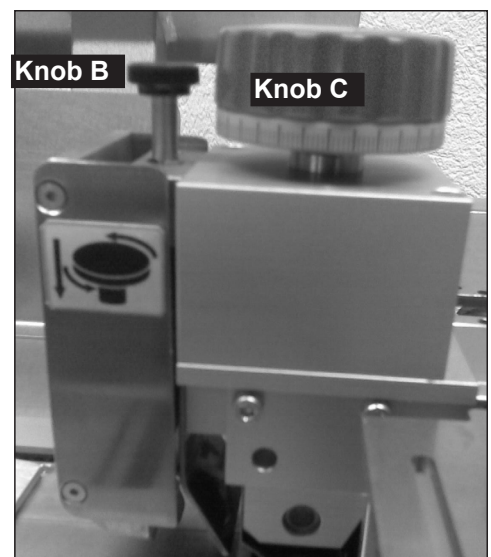

## 2 • Operation

---

### **Feeder Head Adjustment for booklets 2.5mm thick or greater**

Open the F767 Top Cover.

Turn knob **c** anticlockwise until it stops.

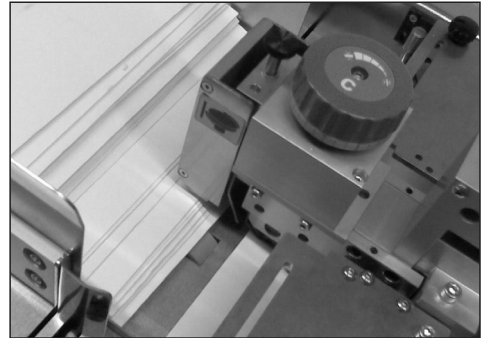

Raise lever **a** to unlock Feeder Head.

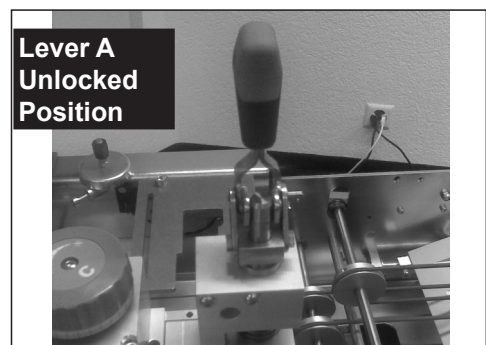

Place a booklet all the way under the first and second rollers.

Lower lever **a** to lock Feeder Head.

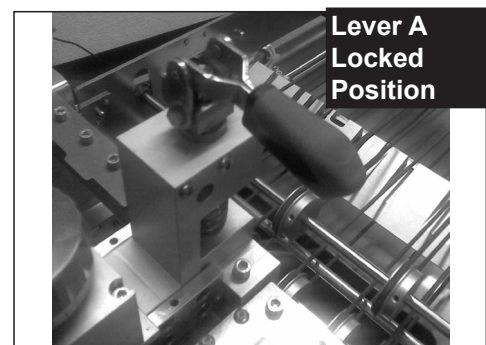

Try to slide a second booklet under the separator. If it goes under, pull it back and turn knob **c** clockwise enough so that a second booklet cannot slide under the separator.

Close the cover.

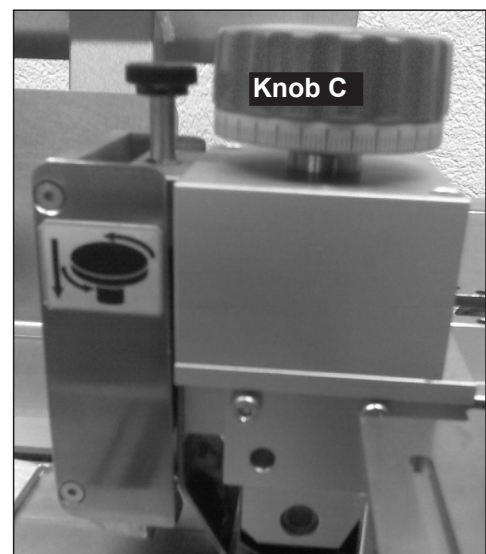

**Transport  
Material to  
Accumulator**

Lower the Front Cover and turn knob **g** anticlockwise to open the Accumulator Side Guides. Close the Front Cover.

Load a sheet or booklet.

Press **Run Confirm (Green)** until a piece is fed into the accumulator area.

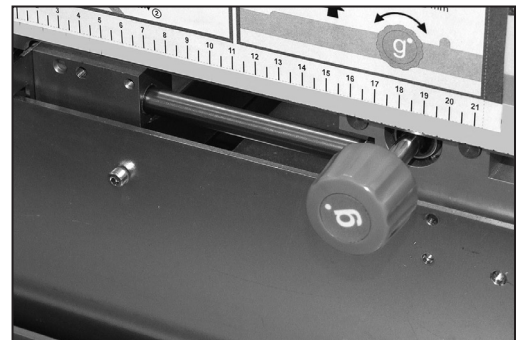

**Setting the  
Accumulator  
Side Guides**

Raise the F767 Top Cover and lower the Front Cover.

Rotate knob **g** clockwise to set the Accumulator Side Guides. The correct setting allows approximately 3mm overall clearance so that the material is controlled but not restricted.

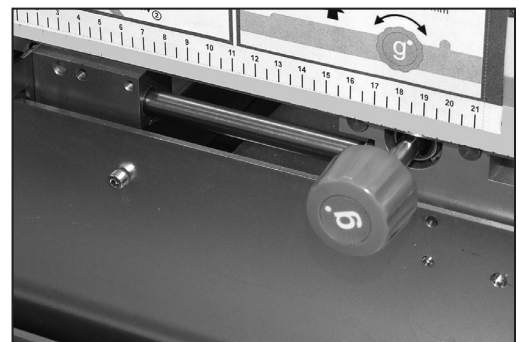

**Accumulator  
Ramp  
Adjustment**

Ensure a piece of material is in the accumulator area as in the Accumulator Side Guide setting above.

Squeeze the tabs **e** together and slide the ramp until the yellow indicators on the ramp align with the material rear edge.

Close all covers.

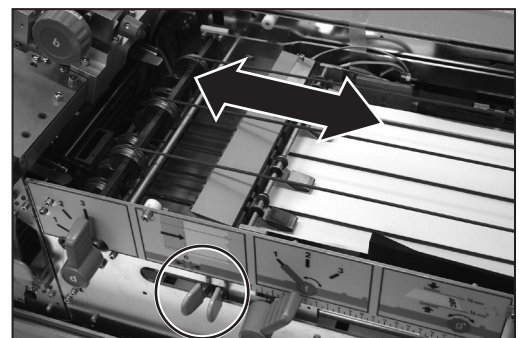

## 2 • Operation

---

### **Deactivate Inline Test?**

The normal response to this is to select **Green** to deactivate, and the material will transport from F767 to the Inserter.

**TIP:**

Should you want to test any aspect of the job setup before the material is transported to the inserter, select **Red (No)** to the prompt and the sheets will be stacked in the F733 Outsort Tray.



### **Load Paper**

You only need to carry out this step if you are NOT using the F774/F772 High Capacity Loaders. If the loader IS being used, it will automatically load sheets onto the F767's Feed Deck. See F774/F772 setup on the next page.

Flex and aerate the material stack to ensure good separation.

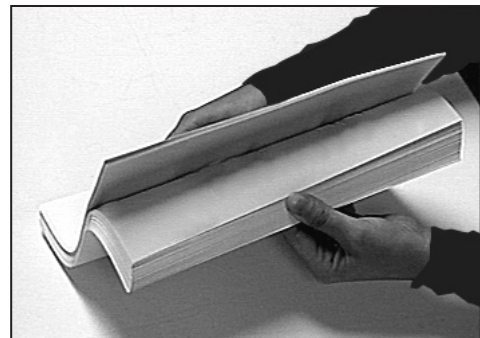

Position the stack on the Feed Deck in the correct orientation for the job being run:

- 1 Face up, bottom first
- 2 Face up, top first
- 3 Face down, bottom first
- 4 Face down, top first



**IMPORTANT:** Fan the paper stack as shown in the photograph, with the bottom sheets in the stack leading.

**TIP:**

When initially loading the paper stack, load about 200 sheets then fully load the feeder once you commence operation. The F767 can be reloaded while the system is in operation.



## Running the System

Once a program is selected and material loaded, the F767 is controlled by the DI900/DI950 Inserting System's control panel. Use the DI900/DI950 controls to run a Trial Piece and to start and stop continuous operation.

If the F767 is running an OMR program, three blocks will show on the display as illustrated below. When running non-OMR jobs, blocks 2 and 3 only will show on the display.

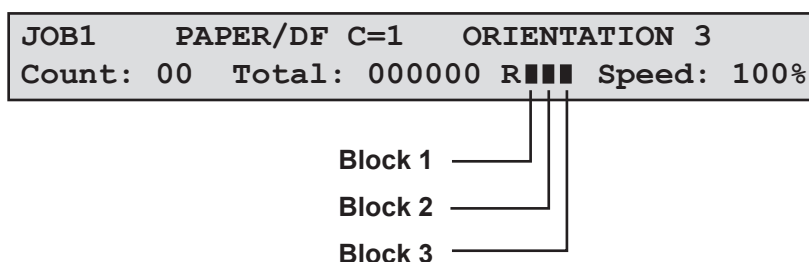

- Block 1** shows that the F767 has read the first scan dash mark on the page, indicating that the scanning system is functioning.
- Block 2** shows that the F767 has confirmed to the Inserter that the collation on the conveyor is ready for transfer into the Inserter.
- Block 3** indicates that the Inserter has sent back a collation signal to the F767.

The F767 will continue operation until:

- You stop it by pressing **Stop/Clear Deck (Red)**.  
or
- You open one of the covers. The safety interlock switch will stop the machine.  
or
- The material runs out or stalls. In this case the machine will stop automatically.

**TIP:**

At the completion of each job run, it is recommended that you check the two trays in the F733 Outsort Tray for diverted sets.

## 2 • Operation

---

# 3 • Programming

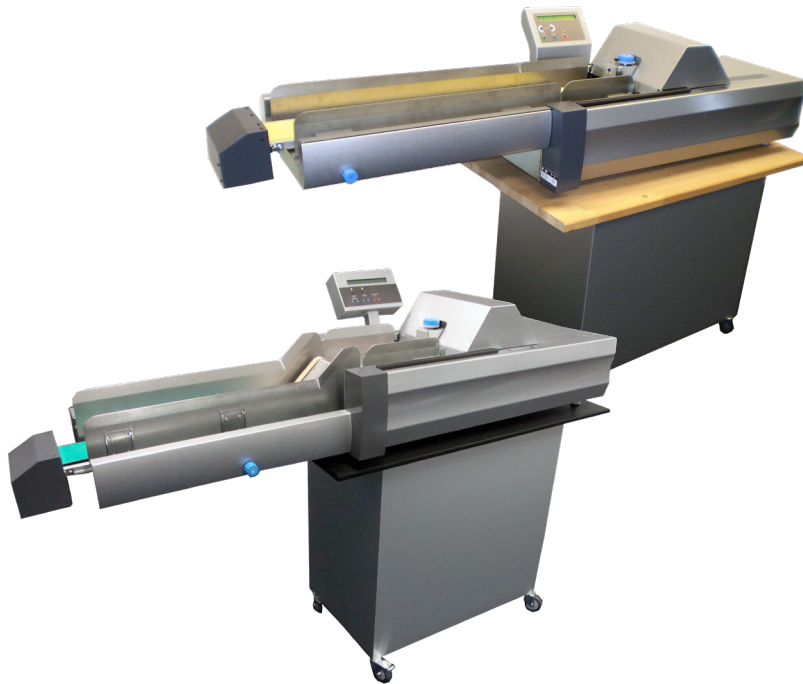

This chapter explains how to program and manage jobs that can be held in the F767 Document Feeder's memory.

About Programming Jobs .....	3-2
Adding a Non-Scanning Program .....	3-2
Adding a Scanning Program .....	3-5
Programming an 'OMR DI900/DI950' Job .....	3-5
Programming a 'BCR Standard' Job .....	3-11
Deleting a Program .....	3-13
Modifying a Program .....	3-14

## 3 • Programming

---

### About Programming Jobs

The F767's memory holds up to 99 pre-programmed jobs that you can recall with a few button presses.

This chapter explains how to program jobs into the system. It commences with a non-scanning job and follows with some examples of typical scanning jobs.

The range of scanning options and job requirements available mean that not all possibilities can be covered in a document such as this. The examples chosen will allow you to understand the programming procedure so that you can adapt it to meet your individual requirements.

### Adding a Non-Scanning Program

This section covers programming a job where scanning is not required. To program the feeder for a scanning job, see page 3-5. When you program the F767 for a particular non-scanning job, you:

- Assign the job a name and/or number
- Enter a batch count (if required)

**HINT:** We advise you keep a 'hard copy' of all your programmed jobs for your own future reference.

#### Step-by-Step Instructions

With the feeder ON, press the **Green**, **Blue** and **Red** buttons at the same time. The display will show:

```
Select: NEW NON-SCANNING JOB
<-->=SELECT      Green=Confirm      Blue=EXIT
```

Press the **Green** button to select 'NEW NON-SCANNING JOB'.

**NOTE:** If you press the **Blue** button, you will return to the job listing screen.

The display shows the program naming screen:

```
017> Name of new program : _____
<-->=ALPHA      Green=CONFIRM      Red=GO ON
```

You can enter a program name up to eight characters long, using any combination of alpha and numeric characters.

Use the **Arrow Buttons** until the first character of your program name appears.

Press the **Green** button to confirm each character.

When the name is complete, press **Red** to continue. The display shows the material selection screen:

```
017> Material: PAPER/DF
<-->=SELECT   Green=CONFIRM   Blue=EXIT
```

Use the **Arrow Buttons** to select the material for this job:

- |                   |  |
|-------------------|--|
| <b>Paper/DF</b>   | Sheets with double detect turned <b>ON</b> (default setting). This will be the most common setting for sheets.   |
| <b>Paper</b>      | Sheets with the double detect turned <b>OFF</b> . This is not recommended as the feeder will not sense double feeds. Select this mode for material (sheets) above 160g/m <sup>2</sup> (42 lb). |
| <b>Booklet</b>    | Booklets with separator motor turned <b>OFF</b> . This is the normal mode for booklets. Double Detect is disabled with this mode.  |
| <b>Booklet/RM</b> | Booklets with separator motor turned <b>ON</b> . This is used for special applications. Double Detect is disabled with this mode.  |
| <b>Paper/DF+</b>  | Sheets with double detect turned on at a custom setting. This is normally used for sheets with heavily printed block areas and will be used only on advice from your service representative.   |

**Note:** Switch the Loader to Off to load material manually.

Press **Green** to confirm your selection. The display shows the material loading orientation selection:

```
017> Loading orientation : 3.DOWN-BOTTOM
<-->=SELECT   Green=CONFIRM   Blue=EXIT
```

Use the **Arrow Buttons** to select the material loading orientation:

- 1 Face up, bottom first
- 2 Face up, top first
- 3 Face down, bottom first
- 4 Face down, top first

Press **Green** to confirm your selection. The display shows the counter selection:

### 3 • Programming

---

017> Counter : 01 Sheets <-->=VALUE      Green=CONFIRM      Red=GO ON
--

Setting a count tells the feeder how many sheets are in each collated set. The F767 will collate the requested number of forms before transporting them into the DI900/DI950 system. The default setting is 01 – a single sheet insert (one piece per cycle). The count can be set from 01 to 25.

- a. Use the **Arrow Buttons** until the first number of your entry appears, then press **Green** to enter the number.
- b. Repeat this process for the second digit.

The display will return to the program listing display.

Programming a non-scanning job is now complete.

## Adding a Scanning Program

Background information on scanning is given in the DI900/DI950 Operating Guide. This section assumes you understand scanning and how it applies to the job you are programming. It also assumes you are familiar with programming non-scanning jobs as described on page 3-2.

**NOTE:** If you select booklets, no scanning is available.

The following sections give two examples of setting up scanning jobs. One for OMR scanning and one for BCR scanning.

**HINT:** We advise you keep a 'hard copy' of all your programmed jobs for your own future reference.

## Programming an 'OMR DI900/DI950 Job

When you program the feeder for an OMR scanning job, you enter the program in a similar way as a non-scanning job, then...

- Specify the scan line increments
- Select the scan functions you wish to use
- Specify the distance from the lead edge to the bench mark
- Specify where each scan line is in relation to the first line

### Step by Step Instructions

With the feeder ON, press the **Green**, **Blue** and **Red** buttons at the same time. The display shows the program type selection:

```
Select: NEW NON-SCANNING JOB
<-->=SELECT      Green=Confirm      Blue=EXIT
```

Press the **Arrow Buttons** to select 'NEW SCANNING JOB'.

```
Select: NEW SCANNING JOB
<-->=SELECT      Green=Confirm      Blue=EXIT
```

Press **Green** to enter the scanning programming mode.  
The display shows the program naming screen:

## 3 • Programming

---

```
018> Name of new program : _____
<-->=ALPHA      Green=CONFIRM      Red=GO ON
```

You can enter a program name up to eight characters long, using any combination of alpha and numeric characters.

Use the **Arrow Buttons** until the first character of your program name appears.

Press the **Green** button to confirm each character.

When the name is complete, press **Red** to continue. The display shows the material selection screen:

```
018> Material: PAPER/DF
<-->=SELECT      Green=CONFIRM      Blue=EXIT
```

Use the **Arrow Buttons** to select the material for this job:

- |                   |  |
|-------------------|--|
| <b>Paper/DF</b>   | Sheets with double detect turned <b>ON</b> (default setting). This will be the most common setting for sheets.   |
| <b>Paper</b>      | Sheets with the double detect turned <b>OFF</b> . This is not recommended as the feeder will not sense double feeds. Select this mode for material (sheets) above 160g/m <sup>2</sup> (42 lb). |
| <b>Booklet</b>    | This function is not used in scanning mode.  |
| <b>Booklet/RM</b> | This function is not used in scanning mode.  |
| <b>Paper/DF+</b>  | Sheets with double detect turned on at a custom setting. This is normally used for sheets with heavily printed block areas and will be used only on advice from your service representative.   |

**Note:** Switch the Loader to Off to load material manually.

Press **Green** to confirm your selection. The display shows the material loading orientation selection:

```
018> Loading orientation : 3.DOWN-BOTTOM
<-->=SELECT      Green=CONFIRM      Blue=EXIT
```



Use the **Arrow Buttons** to select the material loading orientation:

- 1 Face up, bottom first
- 2 Face up, top first
- 3 Face down, bottom first
- 4 Face down, top first

Press **Green** to confirm your selection. The display requests the scanning version:

```
018> Vers.: OMR DI900/DI950
<-->=SELECT   Green=CONFIRM   Blue=EXIT
```

Use the **Arrow Buttons** to select which scanning mode you want. In this example, select 'OMR DI900/DI950'.

Press **Green** to confirm. The display requests the OMR scanner location:

```
018> OMR location : BOTTOM-FRONT
Green=CONFIRM           Blue=EXIT
```

If you have more than one scanning head fitted to your system, you must now tell the system which scanning head to use for this job.

If you only have one scanning head, this step is not required.

Use the **Arrow Buttons** to select where the OMR scanner is located:

Bottom Rear, Bottom Front, Top Rear or Top Front.

Press **Green** to confirm. The display shows the scan line increment selection:

```
018> Scan line increments : 1/6 Inch
<-->=SELECT   Green=CONFIRM   Blue=EXIT
```

Use the **Arrow Buttons** to select the scan line increments. You can select one of the three (1/6", 1/8" or 1/10") scan line increments shown, or you can select a custom 'User Defined' increment. Press **Green** to confirm.

If you select 'User Defined', you must now enter the increment:

```
018> Scan line increments : ___ [0.01MM]
<-->=SELECT   Green=CONFIRM   Blue=EXIT
```

Take a sample of your OMR with the largest number of scan lines you can obtain. Measure the length of the code in millimetres, and then divide this by the number of gaps between lines to obtain an average increment.

### 3 • Programming

---

**Example:** 26mm code length with 6 scan lines gives an increment of 26 divided by 5 (the number of gaps) = 5.2mm

Enter this increment using the **Arrow Buttons**. The figure entered is in units of 0.01mm i.e. in the example above 5.2mm would be entered as 520. Press **Green** to confirm. The display now moves to the scan functions selection:

Use the **Arrow Buttons** to select the scan functions. For each scan line in order as printed on the page, select the function required and confirm by pressing **Green**.

Examples:

Benchmark control in position 1

```
Benchmark control           : [ 1]
<-->=SELECT                Green=CONFIRM
```

Beginning of collation in position 2

```
Beginning of collation      : [ 2]
<-->=SELECT  Green=CONF. Blue=END Red=GAP
```

Select feed 1 in position 3

```
Select feed 1               : [ 3]
<-->=SELECT  Green=CONF. Blue=END Red=GAP
```

End of collation in position 4

```
End of collation/present   : [ 4]
<-->=SELECT  Green=CONF. Blue=END Red=GAP
```

When the required scan functions are set, press **Blue** to exit.

**HINT:**

If you make an error at any time during this process, pressing **Red** will allow you to modify your selections.

**NOTE:**

If your OMR marks are not contiguous (i.e. some mark positions are not being used), you must define where the unused positions are so that the system does not interpret the unused positions as an error. After each scan line function is set, if you wish to insert a gap, press **Red**, select the number of scan positions for the gap using the **Arrow Buttons** and then press **Green** to confirm.

```
UV (Upstream divert)      : [ 3]
<-->=GAP  Green=CONF. Blue=END Red=DEL.
```

You must now enter the distance from the lead edge to the bench mark:

```
Dist. lead edge to bench mark : 00 mm
<-->=VALUE      Green=CONFIRM      Red=GO ON
```

Use the **Arrow Buttons** to set the distance, then confirm by pressing **Green**. Refer to the diagrams below for details of where to take this measurement. In each case, dimension X should be entered.

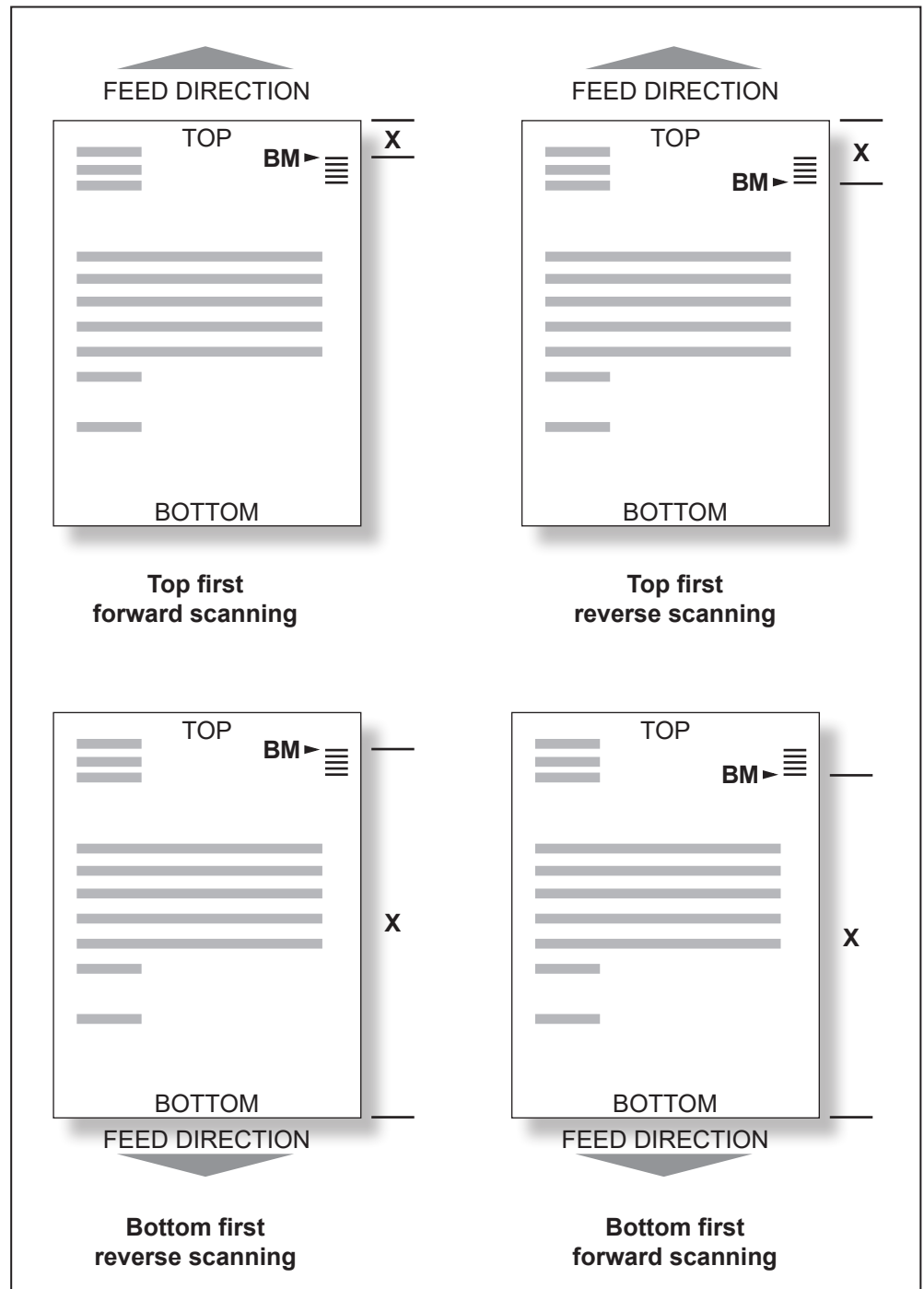

## 3 • Programming

---

You now need to tell the system in which direction to read the scan code:

```
018> OMR scanning : NORMAL
<-->=SELECT      Green=CONFIRM   Blue=EXIT
```

The options available are:

**NORMAL**      Where the system will expect the Bench Mark to be the FIRST mark in the scan code.

**REVERSE**    Where the system will expect the Bench Mark to be the LAST mark in the scan code.

Use the **Arrow Buttons** to select the option you want, then press **Green** to confirm.

**NOTE:**

Take into account the direction of feed of your material when making this setting. i.e. whether the material is being fed top first or bottom first. The setting selected must match whether the Bench Mark is fed past the scanner first or last.

The display will return to the program listing display.

Programming an OMR scanning job is now complete.

**Programming a  
'BCR Standard'  
Job**

**Step by Step Instructions**

With the feeder ON, press the **Green**, **Blue** and **Red** buttons at the same time. The display will show:

```
Select: NEW NON-SCANNING JOB
<-->=SELECT      Green=Confirm      Blue=EXIT
```

Press the **Arrow Buttons** to select 'NEW SCANNING JOB'.

```
Select: NEW SCANNING JOB
<-->=SELECT      Green=Confirm      Blue=EXIT
```

Press the **Green** button to enter the scanning programming mode. The display will show the program naming screen:

```
019> Name of new program : -----
<-->=ALPHA      Green=CONFIRM      Red=GO ON
```

You can enter a program name up to eight characters long, using any combination of alpha and numeric characters.

Use the **Arrow Buttons** until the first character of your program name appears.

Press the **Green** button to confirm each character.

When the name is complete, press **Red** to continue.

The display shows the material selection screen:

```
019> Material: PAPER/DF
<-->=SELECT      Green=CONFIRM      Blue=EXIT
```

Use the **Arrow Buttons** to select the material for this job:

## 3 • Programming

---

<b>Paper/DF</b>	Sheets with double detect turned <b>ON</b> (default setting). This will be the most common setting for sheets.
<b>Paper</b>	Sheets with the double detect turned <b>OFF</b> . This is not recommended as the feeder will not sense double feeds. Select this mode for material (sheets) above 160 g/m <sup>2</sup> (42 lb).
<b>Booklet</b>	This function is not used in scanning mode.
<b>Booklet/RM</b>	This function is not used in scanning mode.
<b>Paper/DF+</b>	Sheets with double detect turned on at a custom setting. This is normally used for sheets with heavily printed block areas and will be used only on advice from your service representative.

Press **Green** to confirm your selection. The display shows the material loading orientation selection:

```
019> Loading orientation : 3.DOWN-BOTTOM
<-->=SELECT      Green=CONFIRM      Blue=EXIT
```

Use the **Arrow Buttons** to select the material loading orientation:

- 1 Face up, bottom first
- 2 Face up, top first
- 3 Face down, bottom first
- 4 Face down, top first

Press **Green** to confirm your selection. The display requests the scanning version:

```
019> Vers.: BCR Standard
<-->=SELECT      Green=CONFIRM      Blue=EXIT
```

Use the **Arrow Buttons** to select which scanning mode you want. In this example, select 'BCR Standard'. Press **Green** to confirm.

The display will now ask where the BCR Scanner is located:

```
019> BCR location : Top Front
<-->=SELECT      Green=CONFIRM      Blue=EXIT
```

Use the **Arrow Buttons** to select where the BCR scanner is located, Bottom Rear, Bottom Front, Top Rear or Top Front. Press **Green** to confirm. Programming a BCR scanning job is now complete.

## Deleting a Program

With the feeder ON, press the **Green, Blue** and **Red** buttons at the same time. The display will show:

```
Select: NEW NON-SCANNING JOB
<-->=SELECT      Green=Confirm      Blue=EXIT
```

Use the **Arrow Buttons** to select 'DELETE JOB'.

```
Select: DELETE JOB
<-->=SELECT      Green=Confirm      Blue=EXIT
```

Press the **Green** button to enter the job delete mode.

Use the **Arrow Buttons** to display the program you want to delete on the **top line** of the display.

**CAUTION:** Make sure you've selected the right program and that you really want to delete it. You can't recover a deleted program. If you accidentally delete a program, you'll have to reprogram the feeder for that particular job.

Press the **Green** button to delete the program.

The display will briefly prompt 'Program \*\*\*\*\* Deleted' and return to the program listing.

## 3 • Programming

---

### Modifying a Program

With the feeder ON, press the **Green**, **Blue** and **Red** buttons at the same time. The display will show:

```
Select: NEW NON-SCANNING JOB
<-->=SELECT      Green=Confirm      Blue=EXIT
```

Use the **Arrow Buttons** to select 'MODIFY JOB'.

```
Select: MODIFY JOB
<-->=SELECT      Green=Confirm      Blue=EXIT
```

Press the **Green** button to enter the job modify mode.

Use the **Arrow Buttons** to display the program you want to modify on the **top line** of the display. Then press the **Green** button to select it.

You can now review the job using the **Arrow Buttons**. You can also edit any of the following parameters:

- Name of program
- Material
- Loading orientation
- Counter (non-scanning job only)
- Scan line increments (scanning job only)
- Distance – Lead edge to bench mark (scanning job only)

To edit any of these parameters, with the parameter displayed:

- Press the **Green** button to select the parameter.
- Press the **Arrow Buttons** to make the change.
- Confirm the change by pressing the **Green** button.



# 4 • *Troubleshooting & Maintenance*

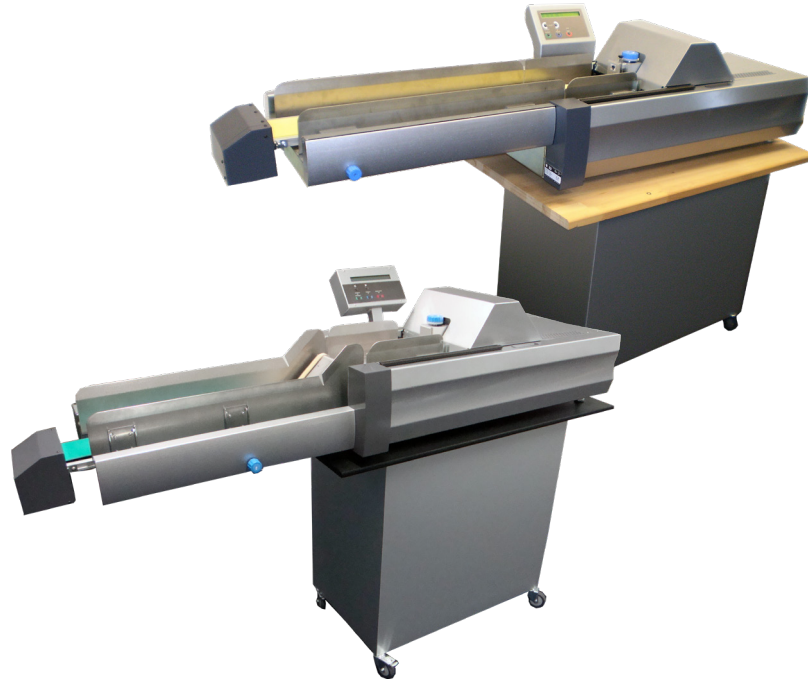

This chapter will help you should you have any problems whilst running your system. It also describes the regular maintenance operations that you can carry out to maintain optimum system performance.

The User's Menu .....	4-2
Options Available .....	4-2
Handling Material Stoppages .....	4-3
Stoppages in the F767 Document Feeder.....	4-3
Troubleshooting Charts .....	4-5
Troubleshooting Using the F767 Scan Error Screens .....	4-8
Operator Maintenance.....	4-8

## 4 • Troubleshooting & Maintenance

---

### The User's Menu

To access the User Menu functions:

Press the **Green**, **Blue** and **Red** buttons at the same time.

Use the **Arrow Buttons** to select 'User Menu', then press **Green** to confirm.

Select: USER MENU <-->=SELECT      Green=Confirm      Blue=EXIT
--

The User Menu offers the options listed below. Use the **Arrow Buttons** to select an option, then press **Green** to confirm.

When you are finished with any option, press **Red** to go to the next selection.

### Options Available

#### Material Feed Belt Cleaning

The Material Feed Belts should be cleaned if the belts appear contaminated and/or if material feed is sluggish.

This option allows you to stop and start the belts using the **Green** button to facilitate cleaning.

Press the button momentarily and the feed belts will run for approximately 3 seconds. Press and hold the button to run the feed belts continuously.

It is recommended that the material feed belts are cleaned weekly with water and a good quality cloth.

#### BCR Test

This function allows you to test that a BCR scanner is reading a code.

When selected, the scanner red lights will flash slowly. Manually position the bar code above or below the scanner as applicable. If the code is read successfully, the lights will flash faster and the characters read will display on the operator display.

#### Total Feed Cycles

This option displays the total cycles that the F767 has performed.

#### Motor Test

#### LED and Key Test

#### Show Sensor Status

#### Double Feed Adjust

These are primarily for service use. Only access these options at the request of a representative of your machine supplier.

### Handling Material Stoppages

This section describes how to clear material stoppages from the F774/F772 High Capacity Loader and the F767 Document Feeder.

#### **Stoppages in the F767 Document Feeder**

The F767 may stop indicating a misfeed. The indicator on the **Stop/ Clear Deck (Red)** button will be flashing.

Follow the relevant procedure below:

#### **Feeder Head section...**

Remove the material from the Feed Deck.

Open the Top Cover. Raise and unlock lever **a** as shown on the right and turn knob **c** fully clockwise.

Carefully clear any material in this area.

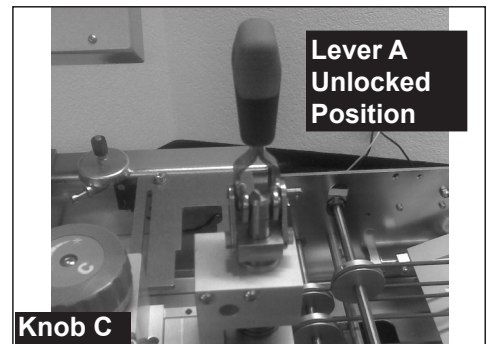

Lower and lock lever **a** as shown on right and turn knob **c** anticlockwise as far as it will go.

Close the Top Cover, reload the paper and press **Run Confirm (Green)** to restart operation.

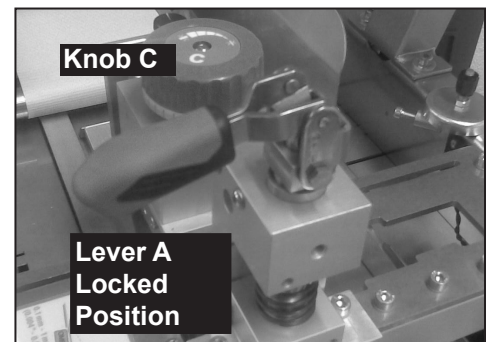

## 4 • Troubleshooting & Maintenance

---

### Accumulator Area...

Open the Top Cover.

Carefully clear any stalled material, taking care not to damage the accumulator drive O rings.

Close the Top Cover.

Press **Run Confirm (Green)** to restart operation.

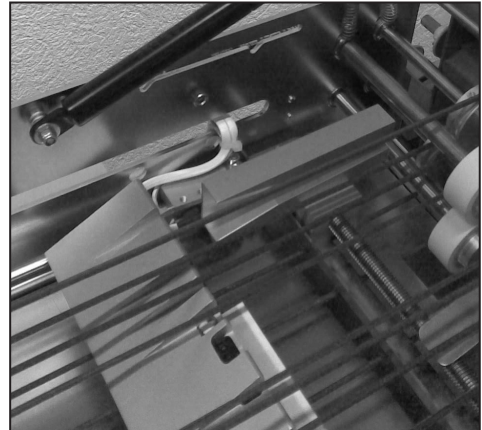

### TIP:

If you are running stiff material, it may aid removal if the Accumulator Ramp **e** is moved out of the way. Make sure you return the ramp to its original position after clearing the stoppage.

### Troubleshooting Charts

The charts in this section describe problems you may see on your system and the corrective action(s) you need to take.

Problem	Possible Cause
<b>System fails to start</b>	No power at outlet. Check the supply circuit breaker or ON/OFF switch.
	Power cord disconnected or Main Power Switch on F774 or F767 turned OFF.
<b>F767 powers up but won't display program list or displays random characters.</b>	F767 program has failed to load. Turn F767 Main Power Switch OFF then ON again to reset. Also make sure that the covers are securely closed. If F767 continues to fail at startup, call for service.
<b>F767 will not respond to controls, display prompts 'Cover Open'. Program button blinks.</b>	A cover is open. Check the F774/F772 Front and Exit Area Covers and the F767 Front and Top Covers. Close all covers securely.
<b>F767 will not respond to controls. Controls appear locked.</b>	Turn the F767 main power switch OFF then ON again to reset. Communication with DI900/DI950 has been interrupted. Power down all modules together, then re-power system. If controls continue to lock, call for service.
<b>F774/F772 will not respond to controls, yellow indicator lights flash.</b>	A cover is open. Check the F774/F772 Front and Exit Area Covers and the F767 Front and Top Covers. Close all covers securely.
	Check for an error condition on the F767 display.
<b>Material feed appears slow/sluggish.</b>	Check for correct position of the F767 Feeder Side Guides (see page 2-6).
	Clean the material feed belts (see page 4-2).
	Check the Feeder Head/Separator adjustments (see page 2-13 for the F767 or page 2-15 for the F774/F772).

## 4 • Troubleshooting & Maintenance

Problem	Possible Cause
<p><b>Material stops in the F767 accumulation area. Display prompts 'Double feed error'.</b></p>	<p>Check the Accumulator Side Guide settings (see page 2-6) and the Ramp settings (see page 2-15).</p>
	<p>Wrong program selected from listing.</p>
<p><b>Material stops in the separation area. Display prompts 'Double feed error'.</b></p>	<p>The F767 has detected a 'Double Feed'. Push the <b>Stop/Clear Deck</b> button to advance the material into the accumulator area for error correction. If double feeds persist, refer to the Feeder Head adjustment on page 2-14.</p>
<p><b>Multiple feed errors or stream feed errors.</b></p>	<p>Check the Feeder Head adjustment (see page 2-13).</p>
<p><b>Feeder display indicates 'DF Sensor Out of Limit'.</b></p>	<p>The material is too thick to be sensed by the double detection system.</p> <p>Check that you have selected the correct program (see page 2-4).</p> <p>Check that the job is programmed correctly i.e. 'Paper' or 'Booklet' (if appropriate) selected in material selection to turn double detect off (see pages 3-2, 3-5 or 3-11).</p>
<p><b>Feeder display indicates 'Current Job Not Compatible'.</b></p>	<p>Check the job setups on the F767 Document Feeder <b>AND</b> the material listed for feeder Y on the DI900/DI950 Inserter to ensure that both have the same material type and loading orientation.</p> <p>If scanning is being used, check it is selected in both the F767 <b>AND</b> the DI900/DI950 programs.</p>
<p><b>Feeder display indicates 'No Material for Double Feed Adjustment'.</b></p>	<p>Take a single sheet and load it onto the F767 Feed Deck (see page 2-5).</p> <p>Material not being transported to Take-Away Roller. Adjust Feeder Head settings (see page 2-13).</p>
<p><b>Feeder display indicates 'Wrong Accumulation Direction'.</b></p>	<p>Check the position of the Accumulator Ramp (see page 2-2).</p>

<b>Problem</b>	<b>Possible Cause</b>
<b>Feeder display indicates 'Wrong Input Frame Position'.</b>	Check the position of the Input Frame (see page 2-2).
<b>Feeder display indicates 'Misfeed on Conveyor'.</b>	Check the Accumulator Side Guides settings (see page 2-6). Check to ensure that the green accumulator belts are properly installed on all pulleys.
<b>Feeder display indicates 'Scan System Error'.</b>	Scanner not positioned correctly above/below the scan marks (see pages 2-8 and 2-9 for OMR, or pages 2-10 and 2-11 for BCR). Scan head may be blocked or dusty. Clean scan head surface with a soft cloth.

## 4 • Troubleshooting & Maintenance

---

### Troubleshooting Using the F767 Scan Error Screens

It is possible to use the Scan Error Screens to check that the Universal Feeder has read the appropriate scan marks. An example Scan Error Screen is shown below:

```
Scan System Error ..... ■.■■- - -  
Green=CONFIRM           Red=RELOAD PAPER
```

If some marks are missing or printed in the wrong position on the material, you will be able to see this by checking the display on the Scan Error Screen.

- a. There should be no marks (black blocks on the display) indicated in the area shown in the illustration below. If marks are shown, a scanning error has been detected.

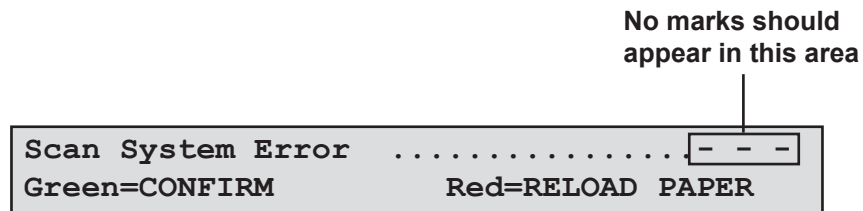

- b. Whenever the sheet feeder stops and indicates a scanning error, you should compare the marks on the Universal Feeder display with those on the material.

In cases a and b above, examine the page which has been transported under the scanning head and into the accumulator area. Check the print quality of the scan dash marks and their positions on the page. If the material appears to be OK, check the scanning program settings on the Universal Feeder, especially the setting 'Lead edge to bench mark' described on page 3-9.

### Operator Maintenance

To aid efficient transport through the conveyor sections of the High Capacity Loader and Universal Feeder, it is recommended that the Material Feed and Transport Belts are cleaned weekly with water.

The 'Material Feed Belt Cleaning' function within the User Menu can be used to assist in belt cleaning (see page 4-2).

The external covers of the units can be cleaned using a non-spirit based cleaner. **Always turn power OFF before cleaning the exterior covers of the system.**



# 5 • Reference

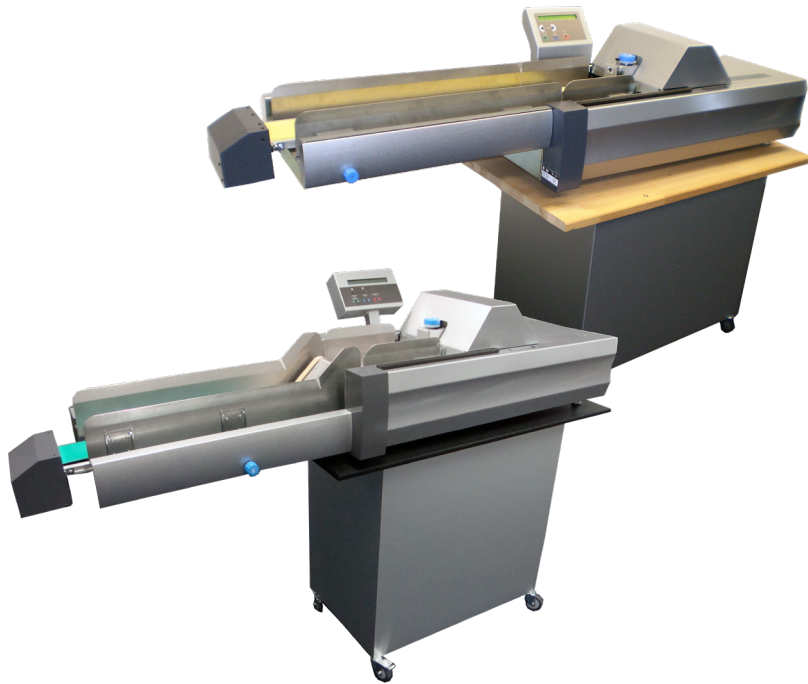

This chapter contains reference information that you might find useful from time to time.

Service.....	5-2
Compliance .....	5-2
Equipment Specifications .....	5-3
Material Specifications.....	5-4

## 5 • Reference

---

### Service

Service for your system is available throughout the world.

Should you have questions about your system, or require service or assistance with your particular application, please call your machine supplier. Contact details are given at the front of this book or in a separate document supplied with your system.

Your machine supplier will also offer a service maintenance contract to keep your system in top condition at nominal cost.

### Compliance

Conforms to the Following:

#### FCC Rules

This equipment has been tested and found to comply with the limits for a Class A digital device, pursuant to part 15 of the FCC rules. These limits are designed to provide reasonable protection against interference when the equipment is operated in a commercial environment. This equipment generates, uses, and can radiate radio frequency energy and, if not installed and used in accordance with the instruction manual, may cause interference to radio communications. Operation of this equipment in a residential area is likely to cause interference, in which case the user will be required to correct the interference at his own expense.

**CAUTION:** Changes or modifications to this equipment not expressly approved by the party responsible for compliance could void the user's authority to operate the equipment.



It is certified that the system complies with all applicable Directives of the European Union.

For a formal Declaration of Conformity please contact Compliance Engineering. Contact information is given in the front of this guide or on a separate document supplied with your system.

**WARNING:** This is a Class A product. In a domestic environment this product may cause radio interference in which case the user may be required to take adequate measures.

**Equipment Specifications**

**Electrical**

F767:	100-240VAC, 50/60Hz, 5A
F774:	100-240VAC, 50/60Hz, 5A
F772:	100-240VAC, 50/60Hz, 5A

**Physical Dimensions**

F767:	480mm High x 600mm Wide x 1000mm Long
F774:	500mm High x 500mm Wide x 900mm Long
F772:	500mm High x 500mm Wide x 900mm Long

**Weight**

F767:	64kg
F774:	60kg
F772:	60kg

**Speed**

Up to a maximum speed of 15,000 sheets per hour.

**Noise Level**

F767:	Below 70 dBA
F774:	Below 30 dBA
F772:	Below 30 dBA

**Operating Temperature Range**

Minimum:	10°C
Maximum:	35°C

## 5 • Reference

---

### Material Specifications

#### ***F767 Document Feeder***

##### **Weight (Sheets)**

60g/m<sup>2</sup> minimum to 165g/m<sup>2</sup> maximum

##### **Thickness (Booklets)**

4mm maximum

##### **Length**

100mm minimum to 297mm maximum

##### **Width**

130mm minimum to 210mm maximum

##### **Feed Tray Capacity (without loader fitted)**

Up to a maximum stack height of 35mm.

Can be reloaded whilst running.

#### ***F774 High Capacity Loader***

##### **Sheet Size**

Length 100mm minimum to 150mm maximum

Width 150mm minimum to 210mm maximum

##### **Capacity**

up to 4,500 sheets

Can be reloaded whilst running.

#### ***F772 High Capacity Loader***

##### **Sheet Size**

Length 200mm minimum to 297mm maximum

Width 150mm minimum to 210mm maximum

##### **Capacity**

up to 4,500 sheets

Can be reloaded whilst running.

# *Index*

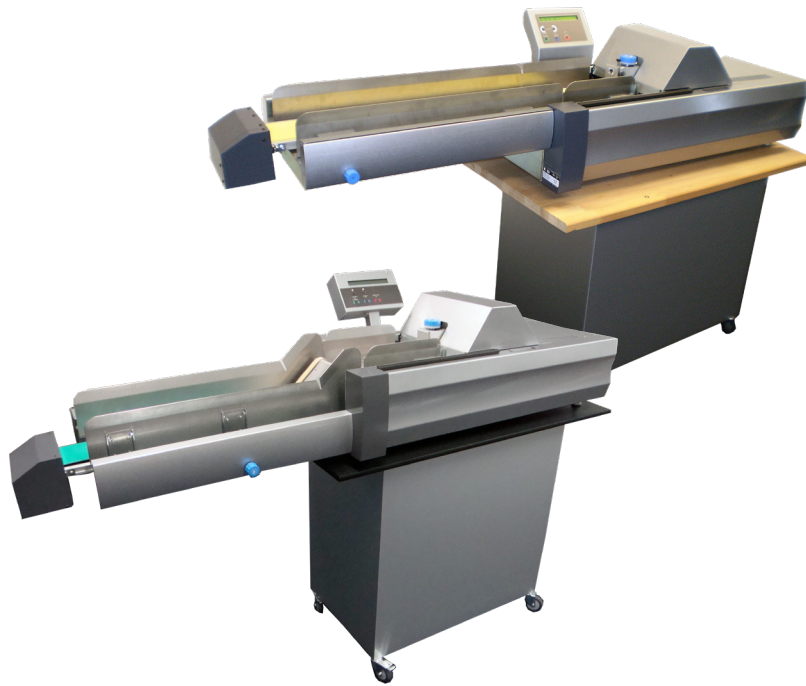

# Index

---

## A

About Your System 1-4  
Accumulation Area 1-6  
Accumulator  
    Input Frame 2-2  
    Ramp 2-2  
    Side Guides 2-15  
    Transport To 2-15  
Arrow Buttons 1-10

## B

Batch Count 3-2  
BCR— See Programming/Scanning  
BCR Test 4-2  
Booklet 3-3, 3-6, 3-12  
    Settings 2-14  
Booklet/RM 3-3, 3-6, 3-12  
Button  
    Arrow 1-10  
    Exit 1-10  
    Run Confirm 1-10  
    Stop/Clear Deck 1-10  
    Stop No 1-10

## C

CE 5-2  
Cleaning  
    Feed Belts 4-2  
    Operator Maintenance 4-8  
Compliance 5-2  
Control Panel 1-6, 1-10  
Count 3-4

## D

Deactivate Inline Test 2-16  
Deleting a Program 3-13

## E

Edit a Program 3-14  
Exit Button 1-10

## F

F731  
    About 1-4  
    Components 1-6, 1-8  
    Controls 1-10  
    Setup 2-2  
    Stoppages 4-3  
F734/F735  
    About 1-5  
Features  
    F731 1-4  
    F734/F735 1-5  
Feed Deck , 2-14, 2-16, 1-6, 4-6  
Feeder Head 2-1, 2-13, 4-5, 4-6, 2-14  
Feeder Side Guides 1-8, 2-1, 2-6, 4-5  
Front Cover 2-2, 2-15

## G

Gap 3-8

## H

Help  
    Troubleshooting 4-1

## I

Important Safety Notes 1-2  
Inline Test  
    Deactivate 2-16

## J

Jam 4-3

## L

Latch - Support 2-2  
Loading Orientation 2-5, 3-3, 3-6, 3-7, 3-12, 4-6  
Load Paper 2-16

## M

Main Power Switch 1-8, 2-3, 4-5  
Material Feed Belt Cleaning 4-2  
Material Guide Fingers 2-7, 2-12  
Material Loading 2-16  
Modifying a Program 3-14

**N**

Normal Scanning 3-10

**O**

OMR— See Programming/Scanning

Operator Display 1-6

Operator Maintenance 4-8

Operator Note 1-4

Orientation 2-16, 3-3, 3-6, 3-7, 3-12, 3-14, 4-6

Outsort 2-16, 2-17

**P**

Paper 3-3, 3-6, 3-12

Paper/DF 3-3, 3-6, 3-12

Paper/DF+ 3-3, 3-6, 3-12

Power Switch 1-8, 2-3, 4-5

Power Up 2-3

Problems 4-1

Program

Display Screen 2-4

List 2-4

Running 2-17

Selection 2-4

Programming

About Programming Jobs 3-2

Adding a Non-Scanning Program 3-2

Adding a Scanning Program 3-5

BCR 3-11

Bench Mark 3-5, 3-9, 3-14, 4-8

Count 3-4

Deleting a Program 3-13

Gap 3-8

Material 3-3

Modifying a Program 3-14

Normal Scanning 3-10

OMR 3-5

Program Name 3-2, 3-6, 3-11

Reverse Scanning 3-10

Scan Function 3-8

Scan Line Increments 1-4, 3-5, 3-7

Scanning Direction 3-10

Scanning Mode 3-7, 3-12

**R**

Ramp

Accumulator 2-2, 2-15

red lever 1-6, 1-6–1-10, 1-6–1-10

Reverse Scanning 3-10

Run Confirm Button 1-10

Running the System 2-17

**S**

Safety 1-2

Scan Error Screens 4-8

Scanning

Bottom Scanning 2-8, 2-10

Display Block 2-17

Function 3-8

Normal 3-10

OMR program 2-17

Reverse 3-10

Scanner Adjustment 2-8, 2-10

Scanning Mode 3-7, 3-12

Separator Controls 1-6

Service 5-2

Side Guides

Accumulator 2-15

Specifications

Equipment 5-3

Material 5-4

Stop/Clear Deck Button 1-10

Stop No Button 1-10

Stoppages 4-3

Support Latch 2-2

System Components

F731 1-6, 1-8

**T**

Top Cover 1-6, 2-2, 2-13, 2-15, 4-3, 4-4, 2-14

Top Scanning 2-9, 2-11

Total Feed Cycles 4-2

Troubleshooting 4-1

Charts 4-5, 4-6, 4-7

Scan Error Screens 4-8

**U**

User's Menu 4-2

BCR Test 4-2

Material Feed Belt Cleaning 4-2

Total Feed Cycles 4-2









3001 Summer Street  
Stamford, Connecticut 06926  
[www.pitneybowes.com](http://www.pitneybowes.com)

For Service or Supplies:

PB Form SDC927D (9-22)

© Pitney Bowes Limited, 2022

We have made every reasonable effort to assure the accuracy and usefulness of this guide, however we cannot assume responsibility for errors or omissions or liability for the misuse or misapplication of our products.



\* S D C 9 2 7 D \*